

PROTECTIVE RIDING JEANS

SAFETY+COMFORT

Sometimes you have those days riding when things go wrong, and it maybe because of someone else and not you - BUT when this happens, you really appreciate the quality and specs of your motorcycle gear.

This is one of the most important things to remember when preparing for a ride, be it a long or short ride. We should feel comfortable in our gear, and also comfortable that our gear improves our level of protection, in case of the unforeseen.

At **MOTODRY**, we always pay attention to the quality and functionality of our products, and our **ORIGINALS Jeans range is no different** - they are thoroughly tested in Australia, by our riders, and also in accordance to meeting the current European standard - EN 17092, which is a CE certification standard for protective motorcycle clothing.



IMPACT ABSORPTION



ABRASION RESISTANCE

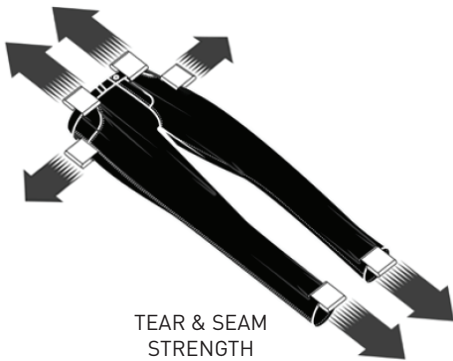

TEAR & SEAM STRENGTH



STRETCH DENIM

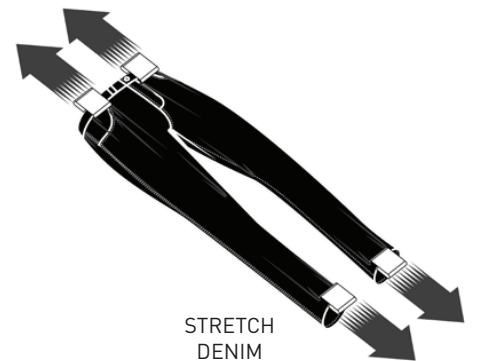

STRETCH DENIM

CE STANDARD

CE certified motorcycle apparel has a "Class" section within the CE label / marking - the shown label / marking identifies 4 different classes of protectiveness: AAA, AA, A, and B (being the lowest).

MOTODRY ORIGINALS jeans are fully CE tested and approved, to surpass the required standard criteria.

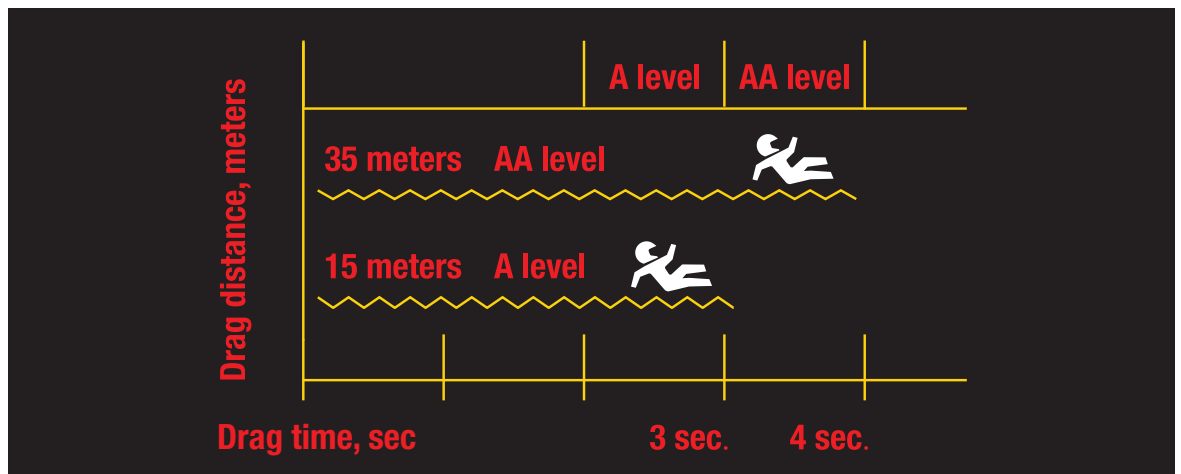

TECHNOLOGY & QUALITY

12oz DENIM + DuPont™ Kevlar®

Denim material has been used in garments for well over 100 years – its long history shows the toughness of the fabric.

Why 12oz Stretch Denim – the Denim material is sturdy & strong enough to give the improved level of wear & protection, as basic denim has for over 100 years, and when added with a Stretch into the weave, it improves the comfort and fit of material in the pants.

In 1965 DuPont™ starting work on developing a synthetic fibre material – by 1971 the fibre had been refined & tested and introduced to the world as Kevlar®.

MOTODRY utilizes DuPont™ Kevlar® in our double-layer jeans, and these garments, using a second layer of protection (made using the DuPont™ Kevlar® thread) have been designed to deliver a very high level of performance, and friction resistance.

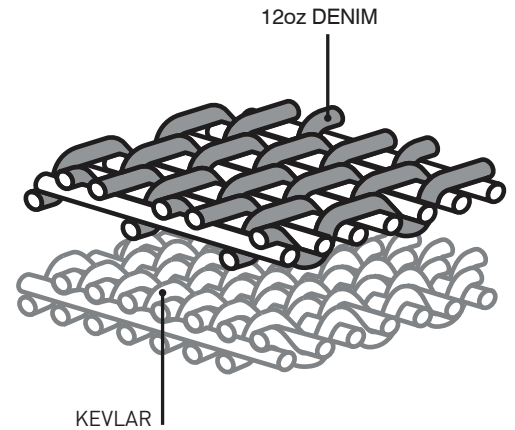

H/DUTY COTTON + DuPont™ Kevlar®

H/DUTY Cotton material has been used in garments forever, and its history shows the versatility & toughness of the fabric, especially in industrial areas. This material is hard wearing & strong enough to give an improved level of wear & protection.

In 1965 DuPont™ starting work on the development of a synthetic fibre material, – by 1971 the fibre had been refined & tested and introduced to the world as DuPont™ Kevlar®.

MOTODRY utilizes DuPont™ Kevlar®, in our double-layer jeans, and these garments, using the second layer of protection (made using the DuPont™ Kevlar® thread) have been designed to deliver a very high level of performance, and friction resistance.

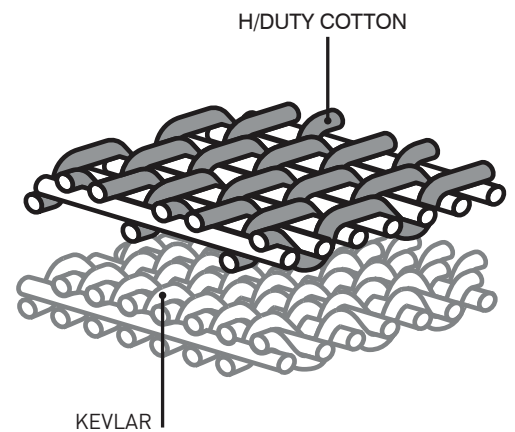
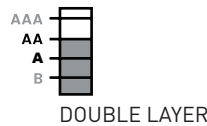

PROTECTIVE RIDING JEANS

FIT & ERGONOMICS

FIT

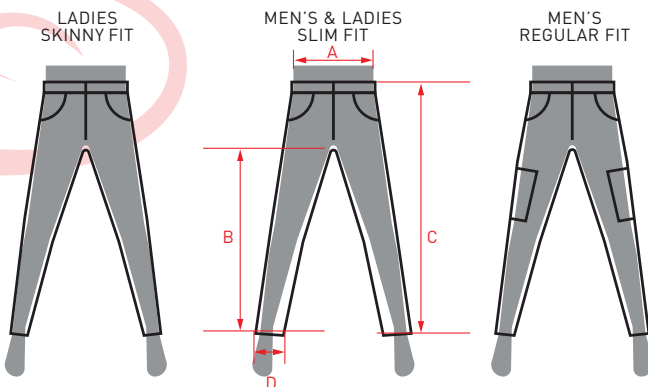

WAIST

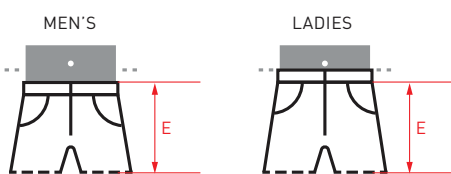

STRETCH

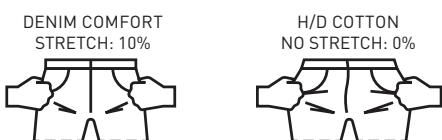

SIZE CHART - MEN'S (UNSTRETCHED MEASUREMENTS) These are the sizes measurement of slim fit in Cms.

		28	30	32	34	36	38	40	42
SLIM FIT	A WAIST	28	30	32	34	36	38	40	42
	B IN-SEAM	79	79.5	80	80.5	81	81.5	82	82.5
	C OUT-SEAM	97	98	99	100	101	102	103	104
	D FRONT-RIS	21	21.5	22	23	24	25	26	26.5
	E BACK-RIS	32	33	34	35	36	37	38	39
	F BOTTOM	14.5	15	15.5	16	16.5	17	17.5	18
	G KNEE	20.5	21	21.5	22	22.5	23	23.5	24

These are sizes chart for Regular fit in Cms.

		30	32	34	36	38	40	42
REGULAR	A WAIST	30	32	34	36	38	40	42
	B IN-SEAM	81	81.5	82	82.5	83	83.5	84
	C OUT-SEAM	103	104	105	106	107	108	109
	D FRONT-RIS	22	23	24	25	26	27	27
	E BACK-RIS	35	36	37	38	39	40	41
	F BOTTOM	17	17.5	18	18.5	19	19.5	20
	G KNEE	22.5	23.5	24	24.5	25	25.5	26

SIZE CHART - WOMEN'S (UNSTRETCHED MEASUREMENTS)

		8	10	12	14	16	18	20	22	24	26
SLIM	A	TBA									
	B										
	C										
	D										
	E										
SKINNY	A	TBA									
	B										
	C										
	D										
	E										

